

| | | | |
|----------------------------------|---|--|--|
| INSTALLATION INSTRUCTIONS | <p>Accessory</p> <p>PLASTIC HOOD PROTECTOR</p> | <p>Application</p> <p>2013 – VELOSTER TURBO</p> | <p>Publication No.</p> <p>HD 10Q13</p> <p>Issue Date</p> <p>January 25, 2013</p> |
|----------------------------------|---|--|--|

PARTS LIST

Hood Protector Installation Tape



Hood Deflector



Large Pedestals (3)

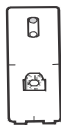

Clip Bodies (4)



Pins (7)



6 x 5/8" Flat Head Screws (7)



Anti-abrasion Film Pads Large (4)



Anti-abrasion Film Pads Small (2)



Large Metal Mounting Brackets (2)



Metal "L" Brackets (4)



Alcohol Wipes (1)



Tape strip sheet (repositionable) (1)

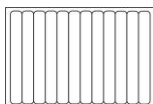

TOOLS AND SUPPLIES REQUIRED

- Long Shank Phillips Screwdriver #2
- Tape Measure
- Grease Pencil
- Masking Tape

INSTALLATION

- Make sure the vehicle is clean and completely dry before installation.
- This product uses a 3M adhesive product that requires installation and curing temperatures of at least 20°C/ 70°F for 24 hours to develop maximum adhesion to the surface. Failure to install this product at the proper temperature or allow adequate curing time before use is not covered under warranty.
- Proper installation of the adhesive pedestal system requires the use of a #2 Phillips screwdriver, preferably with a long shaft. The shaft of the screwdriver needs to fit through the hole in the pedestal. Use of the correct screw driver will facilitate a trouble free installation. Do not attempt to use #1 or smaller Phillips screwdriver or any type of electric screwdriver.



1. Insert a pin through the hole in the Hood Protector Installation Tape supplied and into one of the large adhesive pedestals.
2. Install one of the #6 x 5/8 flat head screws into the pedestal.

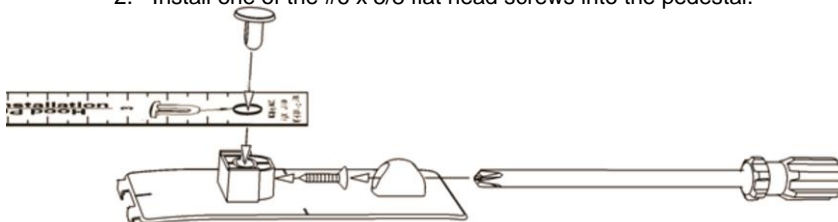

Locate centre pedestal using installation tape.

3. Estimate the centre of the hood and using masking tape or the repositionable tape strips supplied, tape the pedestal into position.
- Use the installation tape to confirm centre by measuring two opposite corners of the hood and adjust pedestal until both measurements are identical.

NOTE: The fingers incorporated on the leading edge of the pedestal will help ensure the correct position relative to the hood edge. When correctly positioned the fingers should contact the leading edge of hood

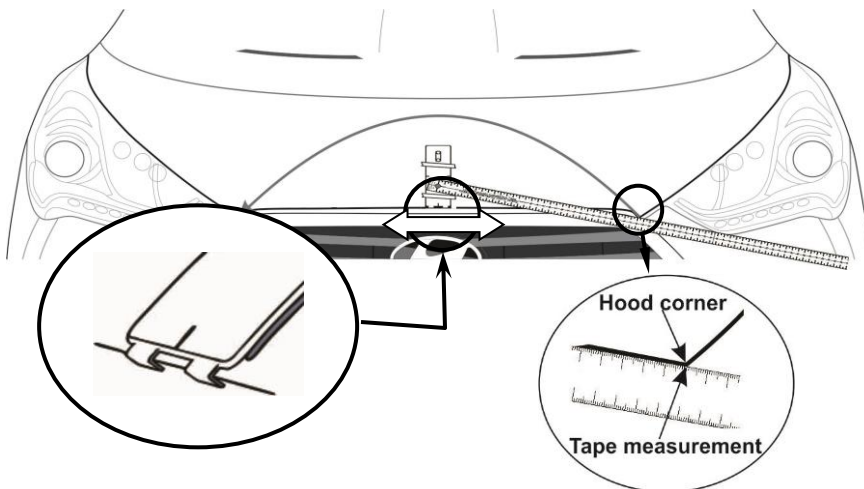

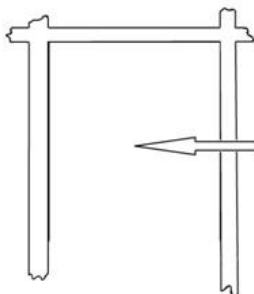
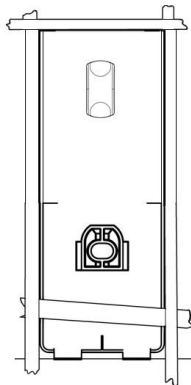
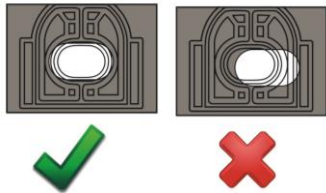
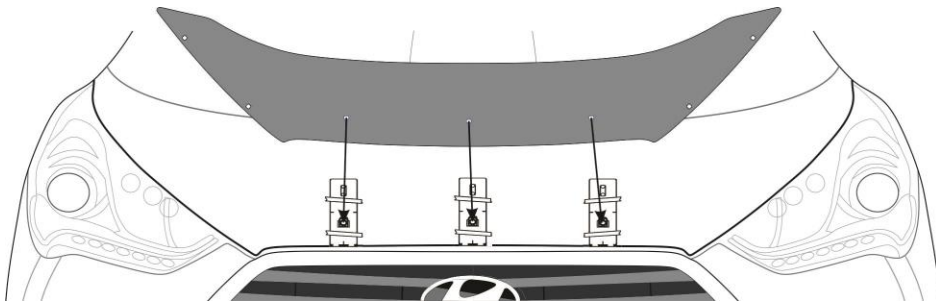
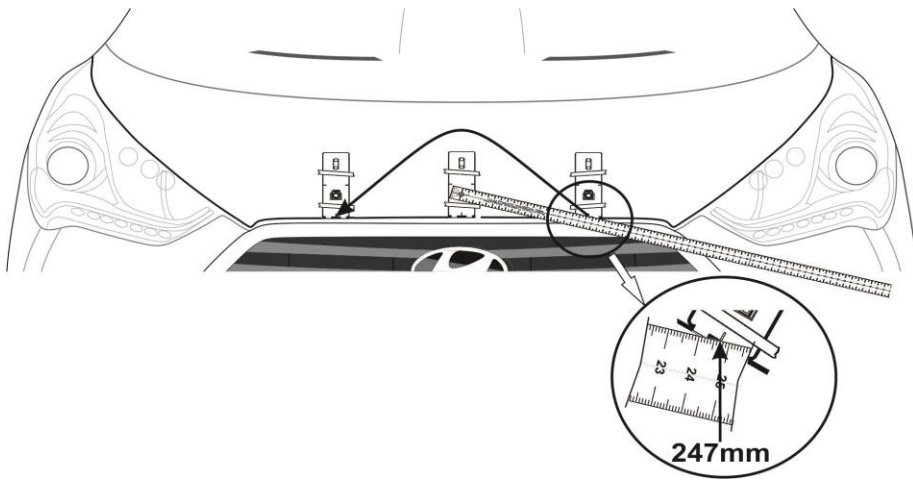

Locate other pedestals using installation tape.

4. The positions of the pedestals are shown in the **illustration**. Use the center mark on the leading edge of the pedestals for accurate measuring. The fingers incorporated on the leading edge of the pedestal will help ensure the correct position relative to the hood edge. When correctly positioned the fingers should contact the leading edge of the hood.

5. Place the hood deflector on the pedestals to confirm proper positioning. Ensure the holes in the deflector align with those in the pedestals. If necessary, reposition the pedestals so all attachment positions are correct and the deflector is well centered.

6. Remove the hood deflector, and outline the perimeter of the pedestals with masking tape or the repositionable tape strips supplied to help final installation.

7. Remove the pedestals and thoroughly clean the outlined area with the alcohol wiping pad. This will insure all wax, finger prints and oils are removed from the hood surface in the bonding area.



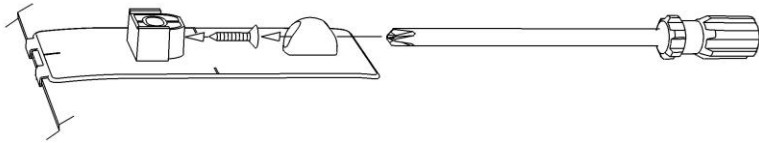
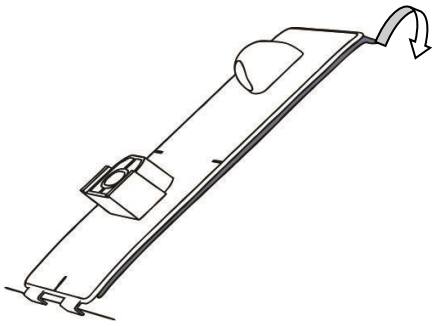

Note: Steps #11 & #12 do not include the centre pedestal.

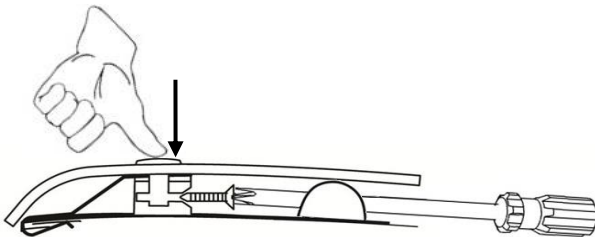
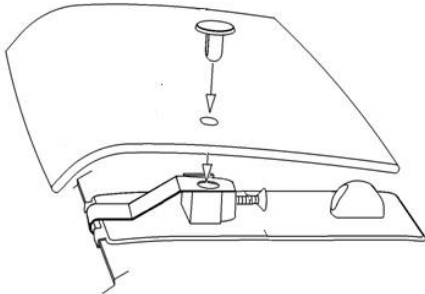
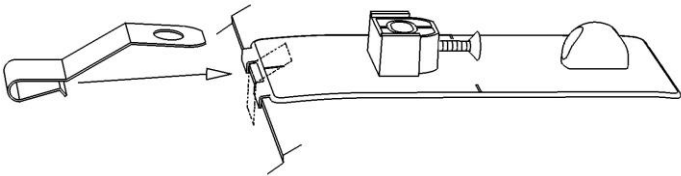
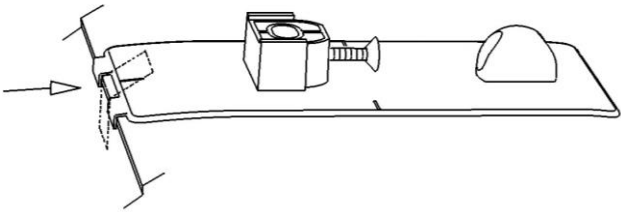

8. Remove the protective backing film from each of the adhesive pedestals and install them on the hood surface.

Tip: Hook the fingers on the pedestal over the hood edge and rotate the unit into position. After installation, remove the masking tape and “wet out” the pedestal base by applying pressure with your thumb around the surface of the pedestals.

9. Start a #6 x 5/8 flat head screw into each pedestal a few turns. The tip of the screw must not protrude into the hole where the attachment pin will install later.

10. Peel and fold the small anti abrasion film pad in half over the hood edge between the fingers on each of the pedestals.

11. Push a metal mounting bracket over the hood edge on top of the anti abrasion pad installed previously. Ensure the bracket is fully engaged over the hood edge and the hole in the bracket is aligned with the hole in each of the pedestals.

12. Place the deflector on the pedestals and drop a pin through the deflector and into the pedestal.

13. Maintain slight pressure on the pin, to ensure proper seating of the components, while simultaneously tightening the screw. Repeat for remaining pedestal locations.



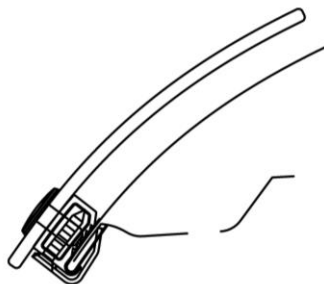
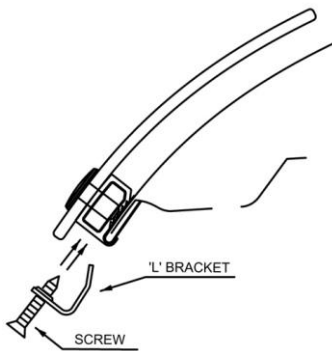
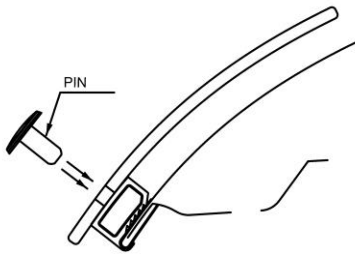
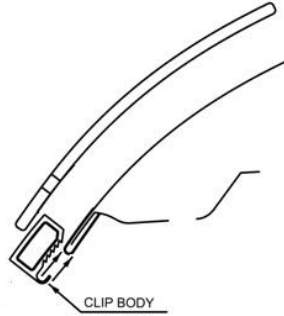
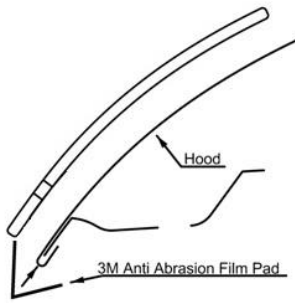

14. Peel and fold two (2) of the large anti-abrasion film pads in half over the hood edge aligned with the inner holes of the deflector in the area above the headlights.

15. Place a clip body over each of the anti-abrasion film pads on the edge of the hood.

16. Insert a pin through the protector into each of the clip bodies.

17. Insert a #6 x 5/8" screw through an 'L'- bracket and into the clip body.

18. Make sure all the components are well seated together; the protector is centered on the hood, and then tighten the screws into the clip bodies.

19. Repeat steps 14- 18 for the outer holes of the deflector over the headlights.

20. Tighten all the screws that are in the adhesive pedestals.

CARE

Hand clean the deflector using a mild soap and water solution or plastic cleaner only.

Avoid automatic car-wash equipment where a brush and/or soft cloth come in contact with the hood deflector. Touch-less style automatic car-wash equipment is less likely to harm the air deflector.

Service

Periodically check to confirm the deflector is securely attached to the hood.

WARNINGS

Do not pull/push on the deflector when opening/ closing the hood.